





























Fix montiert



Zubehör: lackierte Schwenkplatte

| Schläuche | | Anschlüsse | Dichtung | Drehgelenk | Achse |
|---|---|--|---|---|---|
| Schwarzer ● Gummi | Schmutz- abweisend | Verzinkter Stahl | Viton® | Edelstahl AISI 304 | Verzinkter Stahl |
|  |  |  |  |  |  |



| Schlauchaufroller | | Schwenkplatte | | Länge | Schlauch Ø | innen | aussen |
|-------------------|---|---------------|--|-------|-------------|--------|-------------|
| 8330.200 | CHF 386.00  | 843005 | CHF 52.00  | ohne | | F1/2"G | F3/8"-1/2"G |
| 8330.201 | CHF 584.00  | 843005 | CHF 52.00  | 12 m | 3/8"/9.5mm | F1/2"G | M3/8"G |
| 8390.200 | CHF 437.00  | 843005 | CHF 52.00  | ohne | | F1/2"G | F3/8"-1/2"G |
| 8390.202 | CHF 699.00  | 843005 | CHF 52.00  | 17 m | 3/8"/9.5mm | F1/2"G | M3/8"G |
| 8430.200 | CHF 409.00  | 843005 | CHF 52.00  | ohne | | F1/2"G | F1/2"G |
| 8430.201 | CHF 648.00  | 843005 | CHF 52.00  | 10 m | 1/2"/12.7mm | F1/2"G | M1/2"G |
| 8430.202 | CHF 664.00  | 843005 | CHF 52.00  | 15 m | 1/2"/12.7mm | F1/2"G | M1/2"G |
| 8530.200 | CHF 529.00  | 853005 | CHF 56.00  | ohne | | F1/2"G | F1/2"G |
| 8530.201 | CHF 869.00  | 853005 | CHF 56.00  | 20 m | 1/2"/12.7mm | F1/2"G | M1/2"G |
| 8540.200 | CHF 753.00  | 854005 | CHF 128.00  | ohne | | F1"G | F1"G |
| 8540.202 | CHF 1'353.00  | 854005 | CHF 128.00  | 20 m | 3/4"/19mm | F1"G | M3/4"G |
| 8540.203 | CHF 1'312.00  | 854005 | CHF 128.00  | 15 m | 1"/25.4mm | F1"G | M1"G |
| 8560.200 | CHF 1'324.00  | 856005 | CHF 276.00  | ohne | | F1"G | F1"G |
| 8560.205 | CHF 2'357.00  | 856005 | CHF 276.00  | 30 m | 1"/25.4mm | F1"G | M1"G |

■ 50 bar

In Übereinstimmung mit Richtlinie II 2 GD

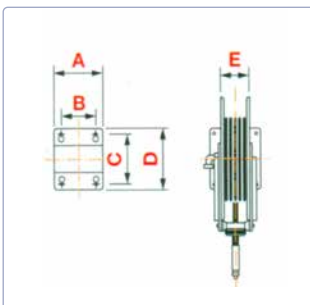

Abmessungen Fixe Ausführung

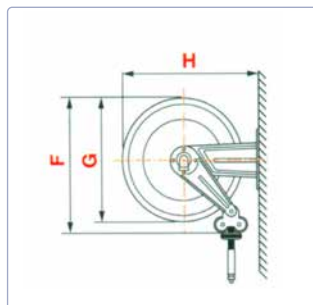

| Art. | A | B | C | D | E | F | G | H | I |
|---------------|-----|-----|-----|-----|-----|-----|-----|-----|----|
| S. 330 | 186 | 140 | 196 | 226 | 110 | 310 | 300 | 320 | - |
| S. 390 | 186 | 140 | 196 | 226 | 110 | 355 | 350 | 365 | 20 |
| S. 430 | 186 | 140 | 196 | 226 | 110 | 400 | 390 | 410 | 20 |
| S. 530 | 203 | 153 | 220 | 258 | 115 | 550 | 510 | 560 | 20 |
| S. 540 | 300 | 218 | 228 | 268 | 190 | 550 | 510 | 573 | 0 |
| S. 560 | 488 | 399 | 238 | 272 | 368 | 550 | 510 | 578 | 0 |