



















Fix montiert



Zubehör: lackierte Schwenkplatte

Schläuche	Anschlüsse	Dichtung	Drehgelenk	Achse
Schwarzer ● Gummi	Verzinkter Stahl	Viton® Teflon®	Edelstahl AISI 304	Verzinkter Stahl
				



Schlauchaufroller		Schwenkplatte		Länge	Schlauch Ø	innen	ausen
8330.350	CHF 589.00 	843005	CHF 52.00 	ohne		F3/8"G	F3/8"G
8390.350	CHF 479.00 	843005	CHF 52.00 	ohne		F3/8"G	F3/8"G
8390.352	CHF 789.00 	843005	CHF 52.00 	17 m	5/16"/8mm	F3/8"G	F3/8"G
8430.350	CHF 459.00 	843005	CHF 52.00 	ohne		F3/8"G	F1/2"G
8430.354	CHF 839.00 	843005	CHF 52.00 	18 m	3/8"/9.5mm	F3/8"G	F3/8"G
8530.350	CHF 582.00 	853005	CHF 56.00 	ohne		F3/8"G	F1/2"G
8530.352	CHF 1'093.00 	853005	CHF 56.00 	25 m	3/8"/9.5mm	F3/8"G	F3/8"G
8540.350	CHF 748.00 	854005	CHF 128.00 	ohne		F3/8"G	F1/2"G
8560.350	CHF 1'278.00 	856005	CHF 276.00 	ohne		F3/8"G	F1/2"G

In Übereinstimmung mit Richtlinie II 2 GD  

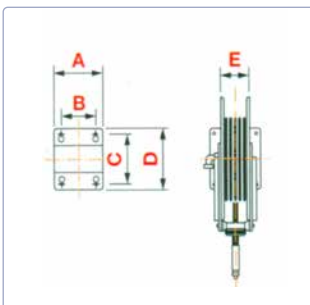

Abmessungen Fixe Ausführung

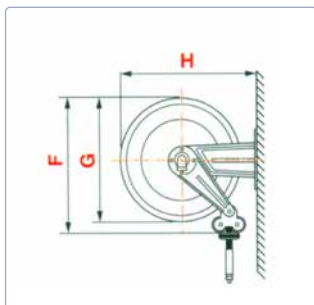

Art.	A	B	C	D	E	F	G	H	I
S. 330	186	140	196	226	110	355	350	365	20
S. 390	186	140	196	226	110	400	390	410	20
S. 430	186	140	196	226	115	460	420	460	20
S. 530	203	153	220	258	115	550	510	560	20
S. 540	300	218	228	268	190	550	510	573	0
S. 560	488	399	238	272	368	550	510	578	0