















Fix montiert



Zubehör: lackierte Schwenkplatte

Schläuche		Anschlüsse	Dichtung	Drehgelenk	Achse
Schwarzer ● Gummi	Schmutz- abweisend	Verzinkter Stahl	Viton®	Edelstahl AISI 304	Verzinkter Stahl
					



Schlauchaufroller		Schwenkplatte		Länge	Schlauch Ø	innen	aussen
8330.200	CHF 386.00 	843005	CHF 52.00 	ohne		F1/2"G	F3/8"-1/2"G
8330.201	CHF 584.00 	843005	CHF 52.00 	12 m	3/8"/9.5mm	F1/2"G	M3/8"G
8390.200	CHF 437.00 	843005	CHF 52.00 	ohne		F1/2"G	F3/8"-1/2"G
8390.202	CHF 699.00 	843005	CHF 52.00 	17 m	3/8"/9.5mm	F1/2"G	M3/8"G
8430.200	CHF 409.00 	843005	CHF 52.00 	ohne		F1/2"G	F1/2"G
8430.201	CHF 648.00 	843005	CHF 52.00 	10 m	1/2"/12.7mm	F1/2"G	M1/2"G
8430.202	CHF 664.00 	843005	CHF 52.00 	15 m	1/2"/12.7mm	F1/2"G	M1/2"G
8530.200	CHF 529.00 	853005	CHF 56.00 	ohne		F1/2"G	F1/2"G
8530.201	CHF 869.00 	853005	CHF 56.00 	20 m	1/2"/12.7mm	F1/2"G	M1/2"G
8540.200	CHF 753.00 	854005	CHF 128.00 	ohne		F1"G	F1"G
8540.202	CHF 1'353.00 	854005	CHF 128.00 	20 m	3/4"/19mm	F1"G	M3/4"G
8540.203	CHF 1'312.00 	854005	CHF 128.00 	15 m	1"/25.4mm	F1"G	M1"G
8560.200	CHF 1'324.00 	856005	CHF 276.00 	ohne		F1"G	F1"G
8560.205	CHF 2'357.00 	856005	CHF 276.00 	30 m	1"/25.4mm	F1"G	M1"G

■ 50 bar

In Übereinstimmung mit Richtlinie II 2 GD

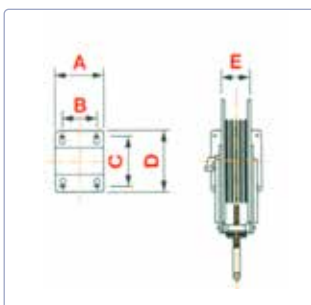

Abmessungen Fixe Ausführung

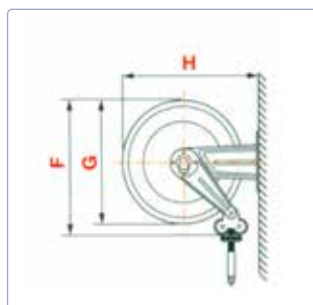

Art.	A	B	C	D	E	F	G	H	I
S. 330	186	140	196	226	110	310	300	320	-
S. 390	186	140	196	226	110	355	350	365	20
S. 430	186	140	196	226	110	400	390	410	20
S. 530	203	153	220	258	115	550	510	560	20
S. 540	300	218	228	268	190	550	510	573	0
S. 560	488	399	238	272	368	550	510	578	0